



# User's Manual UFM919

## Mobile filtration unit



**PASSION TO PERFORM**



# PRODUCT OVERVIEW

## UFM919 filtration unit series

### Key features:

- Transfer
- Filtration
- Flow rates from 90 l/min up to 180 l/min
- Maximum working pressure 10 bar
- Absolute filtration
- Wide range of filtration media
- Water removal filter elements
- Single-phase and three-phase motors
- Comprehensive choice of configurations
- In-line contamination monitoring (ICM2.0 series particle counter)
- Equipped with handles and wheels for easy portability
- CE standard





# DECLARATION OF CONFORMITY

## CE EC declaration DECLARATION OF CONFORMITY IN ACCORDANCE WITH 2006/42/EC MACHINERY DIRECTIVE

The company:

**MP Filtri S.p.A.**  
**Via 1° Maggio, 3**  
**20042 - Pessano con Bornago (MI) - Italy**

as a manufacturer, it declares that the machine:

Name	Code / Model
MOBILE FILTRATION UNIT	UFM919TA3020P01 UFM919TA3021P01

to which this declaration refers, complies with the following Directives: **2006/42/EC Machinery Directive.**

Furthermore, the technical documentation was compiled in accordance with **Annex VII Part A.**

The machine also complies with the provisions of the following standards:

- UNI EN ISO 12100-1-2:2010 Safety of machinery
- UNI EN ISO 13857:2008 Safety of machinery - Safety distances to prevent the reaching into dangerous areas with the upper and lower limbs
- UNI EN ISO 13732-1:2009 Ergonomics of thermal environments - Methods for evaluating human response to contact with surfaces
- UNI EN ISO 4413:2012 Hydraulics - General rules and safety requirements for systems and their components

Pessano con Bornago, 14/05/2019

Chief Executive Officer  
CEO



**PRODUCT OVERVIEW**

Declaration of Conformity	1
Table of contents	3
	4

**GENERAL WARNINGS**

<b>1 General warnings and information for the recipient</b>	6
1.1 General information	6
1.2 General and safety instructions	6
1.3 Operator station and dangerous areas	8
1.4 Hazards and risks that cannot be eliminated	8
1.5 Personal protective equipment	8

**TRANSPORT AND STORAGE**

<b>2 Transport and handling conditions</b>	9
--	---

**GENERAL WARRANTY CONDITIONS**

<b>3 Warranty, limits and exclusions</b>	11
--	----

**PRODUCT DOCUMENTATION**

<b>4 Mobile transfer and filtration units</b>	12
4.1 Test certificate	13
4.2 Download Area	13

# TABLE OF CONTENTS

<b>UFM 919 - MOBILE FILTRATION UNIT</b>		Page
<b>5</b>	<b>Technical features</b>	15
5.1	Dimensions	16
5.2	Hydraulics diagrams and material list	17
<b>6</b>	<b>Installation procedures and general operation</b>	19
6.1	Introduction	19
6.2	Filter element installation	19
6.3	Wiring diagram	20
6.3.1	Electrical connection	20
6.3.2	Triangular electrical connection of a three-phase motor	20
6.3.3	Electrical connection of a single-phase motor	-
6.3.4	Electrical panel	21
6.3.5	Electrical panel labels	21
6.4	Use	22
6.4.1	Installation	22
6.4.2	Power on	23
6.4.3	Air vent	24
6.4.4	Oil analysis with particle counter	24
6.4.5	Shutdown	25
6.4.6	Operating limits and environmental limits	25
6.5	Normal and scheduled maintenance	26
6.5.1	Oil leaks	26
6.6	Filter clogging	26
6.6.1	Replacing filter element	27
6.6.2	Air vent	28
6.6.3	Replacing and cleaning of the filter in the suction line	28
<b>7</b>	<b>Designation &amp; ordering code</b>	29
<b>8</b>	<b>Spare parts</b>	30
8.1	List of spare parts	30
8.2	Filter element detail	32

# 1 General warnings and information for the recipient

## 1.1 General information

The mobile filtration units of the UFM series have been designed and manufactured in compliance with the machinery directive and the low voltage directive with regards to electric motors. The EC Declaration of Conformity is included in this manual. The warranty has a duration of twelve months starting from the date shown on the delivery note. To consult “General Warranty Conditions” section of this Use and Maintenance Manual.

## 1.2 General and safety instructions

Read this manual carefully before commissioning, maintenance or other activities on or with the unit. Each operator involved in the operation of the mobile filtration unit must wear the following personal protective equipment:



Safety glasses



Safety shoes



Gloves

Before carrying out any installation or work on and/or with the machine it is necessary to strictly follow the instructions listed in this manual. It is also necessary to comply with the provisions in force concerning accident prevention and safety in the workplace. The warnings to prevent dangers to the health of the personnel assigned to the machine, are highlighted in this documentation with signal words to notifications:

If important information concerning the product affects the use of the product or a part of this documentation, all of it must be particularly taken into account.



NOTE

This means that failure to comply with the relevant safety regulations may result in slight injury or damage to equipment.



CAUTION

This means that failure to comply with the relevant safety regulations can result in death, serious injury or considerable damage to equipment.



DANGER



# GENERAL WARNINGS

To allow rapid identification of the employees who must read this manual, definitions have been used with the following meaning:

OPERATOR	The person in charge of using the machine for productive purposes. The operator is aware of the measures taken by the machine manufacturer to eliminate the sources of risk of accidents at work and complies with the operational constraints.
PERSONNEL INVOLVED IN SLINGING AND HOISTING OPERATIONS	The person in charge of handling the machine or parts thereof. The slinger is aware of the problems concerning the transport of machines or parts thereof in safe conditions; for this purpose, they use lifting equipment suitable for the purpose following the instructions provided by the machine manufacturer.
MACHINE SETTER	The person in charge of preparing the machine for normal operation. The machine setter is aware of the measures taken by the machine manufacturer to eliminate the sources of risk of accidents at work and complies with the operational constraints. The machine setter takes the necessary precautions to intervene in conditions of maximum safety.
MAINTENANCE TECHNICIAN	The person in charge of performing maintenance operations on the machine. The maintenance technician is aware of the possible dangerous situations that may arise during his work and takes the necessary precautions to avoid risks of accidents at work.
ELECTRICIAN	The person in charge of carrying out maintenance operations on the machine's electrical system. The electrician is aware of the possible dangerous situations that may arise during his work and takes appropriate precautions to avoid risks of accidents at work.

### 1.3 Operator station and dangerous areas

Areas adjacent to the electric motor due to the presence of live equipment and potentially very hot surfaces are to be considered as dangerous areas. The operator has no reason to access electrical equipment and is not authorised to do so.

The trolley must be taken out of service and/or dismantled in full compliance with the regulations in force at that time in the country where the machine is installed.



NOTE

The machine is not suitable for outdoor use and all electrical equipment has a minimum degree of protection IP 55.



NOTE

### 1.4 Hazards and risks that cannot be eliminated

Risk of electric shock on the electric motor, in case of motor malfunction, risk of burns due to high temperature, accidental oil leakage with consequent possibility of slipping, rupture of the hoses with consequent loss of lubricant.

With oil temperatures above 40/45 °C, take extra caution in the handling of metal lances/tubes and movement of the mobile filtration unit. Avoid direct contact with hot oil and the filter housing.

### 1.5 Personal Protective Equipment

For normal use of the mobile filtration unit, safety shoes, gloves and safety glasses must be worn. In general the PPE to be used according to the operations on the machine are summarised in the following table:

OPERATION	PPE
Normal operation	Safety shoes, protective gloves, safety glasses
Normal maintenance	Safety shoes, protective gloves, safety glasses



# TRANSPORT / STORAGE

## 2 Transport and handling conditions

The filtration unit is transported packaged with strapping and plastic film.  
The product is moved by means of wheels. The movement of the same is carried out by acting on the special handle.  
The weight of each individual unit is shown below:

Total weight UFM919	120 kg
---------------------	--------



# GENERAL WARRANTY CONDITIONS

## 3 Warranty, limits and exclusions

- 1 - The seller assumes a guarantee of the normal mechanical operation of their product for a period of one year (except as provided for in Item H4 referred to the general conditions of sale and warranty sent with each order confirmation) from the delivery date.
- 2 - The warranty is limited to the replacement of damaged or defective parts due to poor quality of the material or construction. It does not extend to defects due to normal wear or due to inexperience or negligence of the customer and to parts that due to the composition of the material or the nature of their use are subject to rapid wear.
- 3 - Damage or defects must be declared, under penalty of forfeiture, by registered letter within eight days of discovery. The seller, once being aware of the existence of the defect, is obligated to replace the defective elements if they have not been tampered with due to attempted repair or modification by the customer (or third parties), and provided that he has punctually fulfilled the contractual obligations, with particular regard to payments which, if not carried out in the manner and within the agreed terms, entail the forfeiture of the guarantee and the seller's right not to effect the replacements.
- 4 - Any other indemnity, request for compensation for damages, also by third parties, due to production shutdown of the customer is expressly excluded.
- 5 - The items to be replaced must be sent with transport costs to be paid by the purchaser ex works of the seller who will replace them as soon as possible with delivery to their premises. The replaced parts belonging to the customer remain at his disposal for eight days within which they can be collected; following this deadline the seller is entitled to regard them as scrap in his possession without any compensation.
- 6 - The examination of the failures and their causes will always be carried out in the seller's workshops and all the related costs will be borne by the customer. The customer is also responsible for all inspection costs that may be requested on site. In no case may the customer demand the termination of the contract.
- 7 - The warranty is not transferable and applies only to the invoice recipient.
- 8 - The warranty is no longer valid when one of the following conditions is the case:
  - a) payments are not made by the client in the manner and terms agreed
  - b) tampering with what is provided without the seller's explicit authorisation
  - c) improper use of what is supplied
  - d) failure to perform maintenance
  - e) installation, modification, replacement of parts or of what is supplied

## 4 Mobile transfer and filtration units

The UFM series mobile filtration units are machines designed for transferring and filtering lubricants and hydraulic oils. The UFM015 version can be moved thanks to the use of handle and low weight, all other versions have wheels for moving. They can be used with fluids at different temperatures (therefore different viscosities) as long as they fall within the limits indicated by this manual. Operation with Mineral Oils, Synthetic Fluids & HFCs.

NOTE

The machine can be used for:

### *TRANSFER*

- transferring from drums into tanks
- to refill from drums into tanks

### *FILTRATION*

- off-line filtration in tanks
- additional off-line filtration system in tanks
- off-line filtration of new oil into drums or underground/large tanks
- Particle counting and determination of cleanliness class according to ISO4406, NAS1638, AS4059 (only for versions with ICM mounted on UFM051-091-181-919)
- Measurement of the water saturation level (RH) contained in the fluid and of the temperature

Depending on the version, the mobile filtration units can use filter elements and cartridges with different filtering media, filtration degree and dimensions; the fibre filter elements have high storage capacity and absolute filtration  $B_{x(c)} > 1000$ .

Single-phase and three-phase electric motors.

Wide range of flow rate, from 15 l/min to 180 l/min.

Optical and electrical systems for filter monitoring.

Electrical systems for greater safety:

- unit shutdown in case of clogged filter (from the UFM041 version onwards)
- unit shutdown when the set cleanliness class is reached (particle counter version only).

Before commissioning the equipment make sure:

- you have read this manual carefully
- check the good condition of the mobile filtration unit
- report any damage or breakages suffered by the mobile filtration unit during transport
- verify the presence of all the accessories supplied

# PRODUCT DOCUMENTATION



## 4.1 Test certificate

Hard copy of test certificate is attached to the cart.

## 4.2 Download Area

Please scan the QR codes below to get updated electronic version of the related document.

**MOBILE FILTRATION UNIT**  
General catalogue



Download PDF

**CONTAMINATION MONITORING PRODUCTS** General catalogue





Download PDF

**QUICK GUIDE**  
UFM series









Download multi-language PDF



**USER'S MANUAL - UFM series**



Select your language and download PDF

<p><b>UFM 015</b></p> 	<p><b>UFM 041</b></p> 	<p><b>UFM 051</b></p> 
<p><b>UFM 091</b></p> 	<p><b>UFM 181</b></p> 	<p><b>UFM 919</b></p> 

**ICM**  
User's Guide

Select your language and download PDF

**CMP View Software**  
Software multilingual

Download Software



**CMP View Software**  
Quick Guide



Select your language and download PDF





## 5 Technical features

The mobile filtration unit consists of a support frame with handle and wheels for manoeuvrability. The assembly/motor pump connected to the hoses is used for suctioning and discharging the fluid.

It is equipped with a suction filter and a discharge filter.

The mobile filtration unit is complete with electrical and mechanical safety systems, for the filter and the assembly/motor pump.

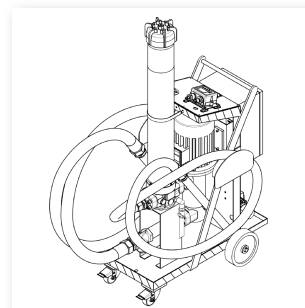

Pump	Screw pump with integrated pressure relief valve
Electric motor	3.7/5 kW 400/230 V three-phase - 2/4 poles
Flow rate (l/min)	90 l/min - 1450 rpm / 180 l/min - 2900 rpm
Max. working pressure	10 bar
Viscosity	Minimum operating viscosity 10 cSt Maximum operating viscosity 800 cSt Maximum only for cold starts 2000 cSt
Suction filter	Y-shape fine filter unit 800 µm
Type of filtering mat/degree of filtration	Fibre 1/3/6/10/16/25 $\beta_{x(c)} > 1000$
Internal/external filtration	Wire mesh 25/60 µm Water absorber
Bypass valve $\Delta p$ set	3.5 bar
Fluid temperature	from -10 °C to +80 °C
Ambient temperature	from -20 °C to +45 °C
Protection class	IP 55
Seals	NBR
Compatibility with hydraulic fluids	Mineral & Synthetic oils. For other fluids contact MP Filtri.
Hoses	Flexible suction hose DN50 L = 3000mm Nozzle $\varnothing_e = 50$ L = 700mm Flexible delivery hose DN38 L = 3000mm Nozzle $\varnothing_e = 42$ L = 700mm
Weight	120 kg
Standard equipment	Main filter bypass valve blocking Pressure gauge Nozzle 90° $\varnothing_e = 40$ L = 700mm
Equipment according to the versions	
UFM919TA3020P01	Electric clogging indicator with automatic motor stop
UFM919TA3021P01	Electric clogging indicator with automatic motor stop, ICM2.0 series particle counter and communication module

NOTE 1/NOTE 2

Microfibre filter elements with water absorber: disposable components

NOTE 1

The system is supplied without filter element

NOTE 2

## 5.1 Dimensions

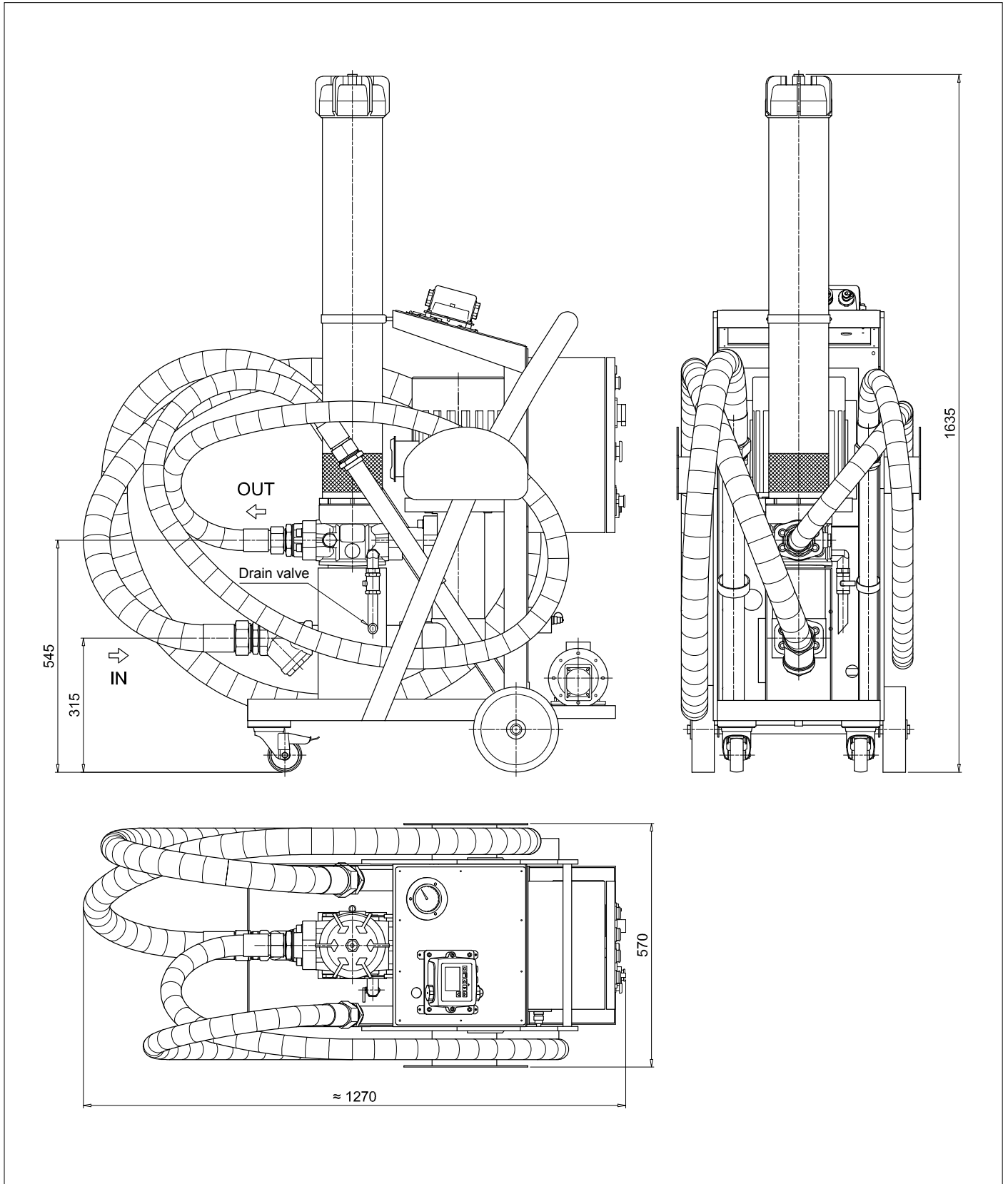

## 5.2 Hydraulic circuit and bill of materials

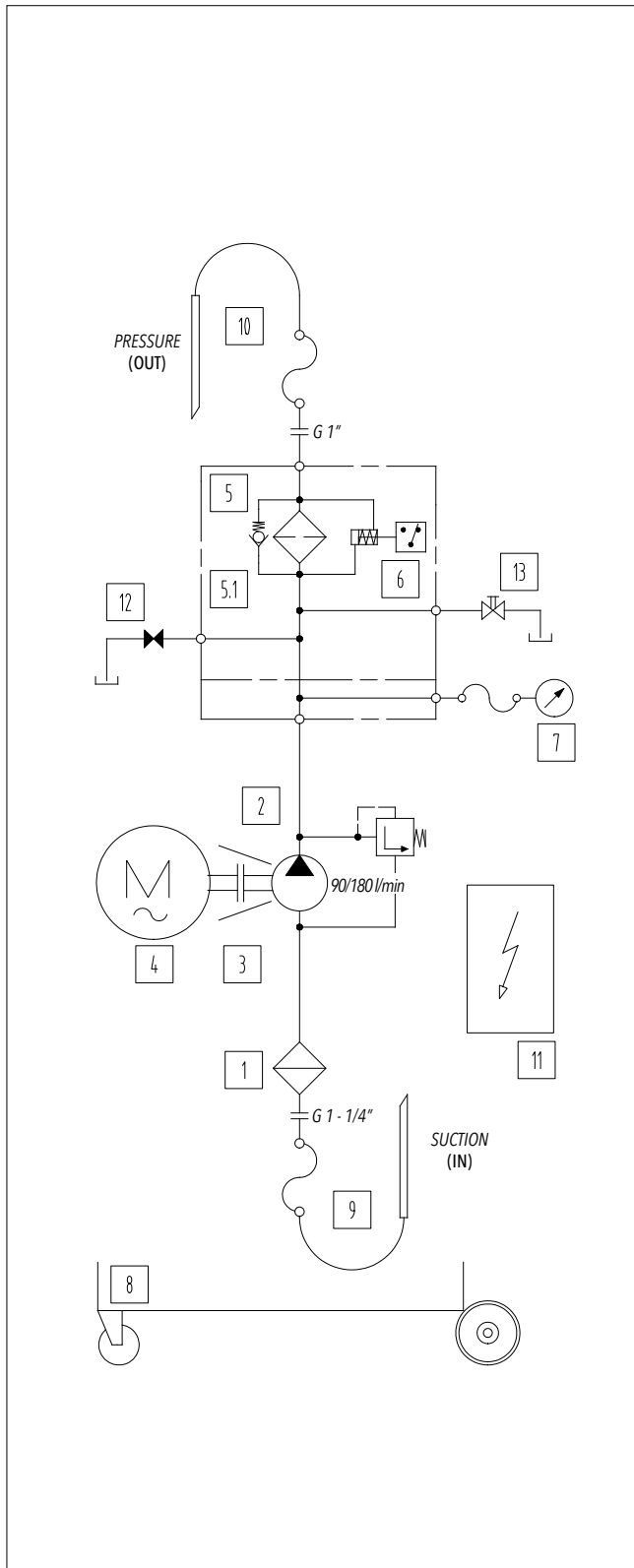

Version:  
UFM919TA3020P01

Position	Quantity	Description
1	1	Y shaped filter 800 µm
2	1	Gear pump / screw
3	1	Motor/pump coupling
4	1	Three-phase electric motor 3.7/5 kW 2/4P-B3/B5 (IE3)
5	1	Increased filter length
5.1	1	Microfibre filter element 1 µm Microfibre filter element 3 µm Microfibre filter element 6 µm Microfibre filter element 10 µm Microfibre filter element 16 µm Microfibre filter element 25 µm Filter element in wire mesh 25 µm Filter element in wire mesh 60 µm Water absorber filter element
6	1	Electric diff. pressure indicator (visual indication on panel)
7	1	Pressure gauge
8	1	Mobile unit frame
9	1	DN50 flexible suction hose + nozzle
10	1	DN38 flexible discharge hose + nozzle
11	1	Electrical panel three-phase version
12	1	Drain valve
13	1	Air vent valve

NOTE

>> NEXT

Microfibre filter elements with water absorber: disposable components

NOTE

>> NEXT

## Hydraulic circuit and bill of materials

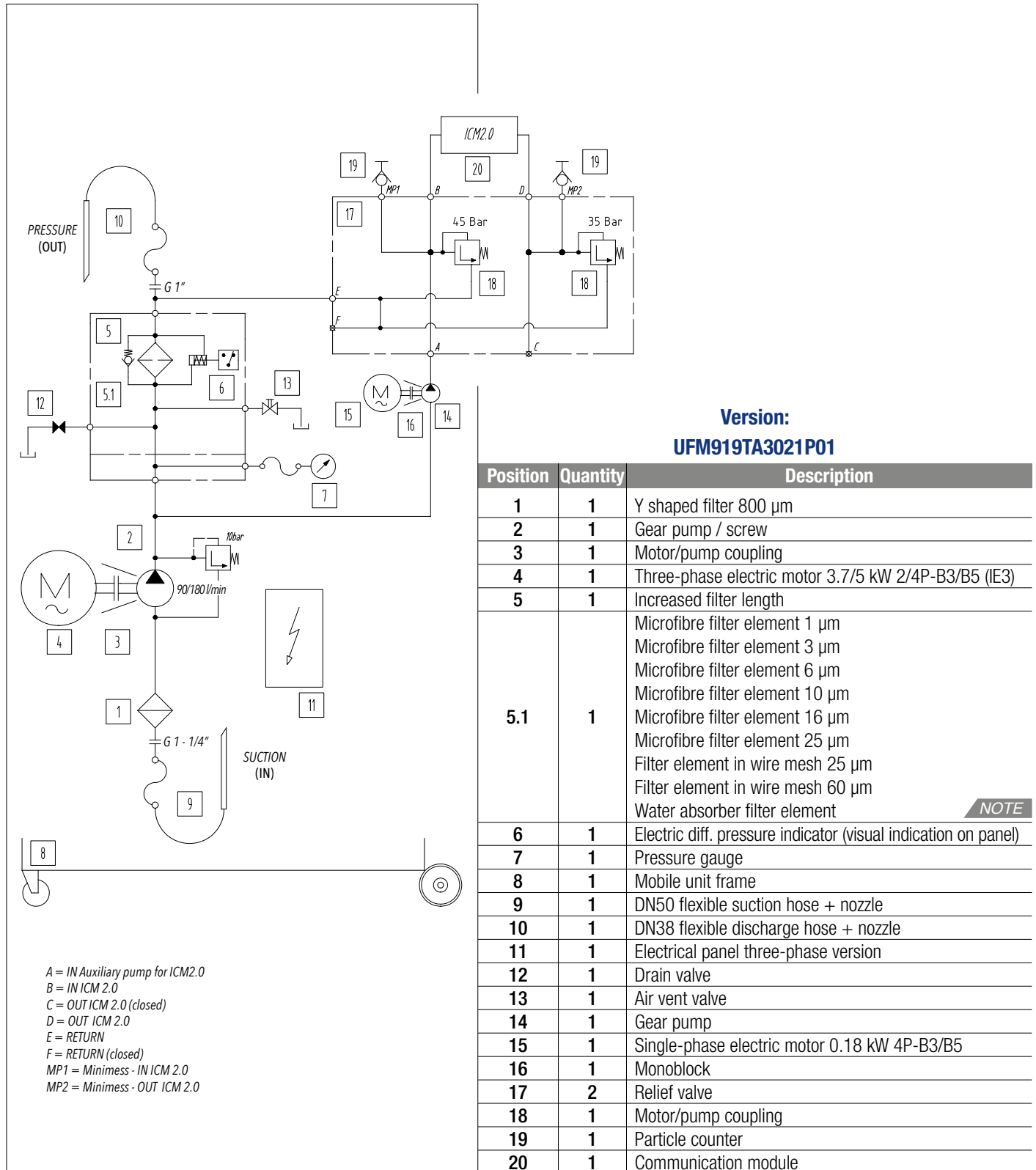

Microfibre filter elements with water absorber: disposable components

**NOTE**

## 6 Installation procedures and general operation

### 6.1 Introduction

The mobile filtration units are suitable for the following fluid operations:

- Transfer with filtration
- Off-line filtration (recommended volume up to 3000L/3500L)

The standard version of the filtration unit is delivered without a filter element, before its use install an original MP Filtri filter element suitable for the type of unit being used (see filter element codes listed in Table 6.7.2 Item.5) and carry out the procedures described in Section 6.2 "Filter element installation".

The filter bypass valve can be locked by replacing the endcap with bypass (Fig. 2) with the included (Fig. 1) blind endcap (Fig. 3).

The endcap is inserted into the filter element.



Scope of supply



Endcap with bypass Fig.2



Blind endcap Fig.3

With the bypass valve blocked pay close attention to the clogging indicator. As soon as the indicator indicates the clogged filter, turn off the filtration unit and replace the filter element.



### 6.2 Filter element installation



1 Loosen the air vent nut



2 Unscrew the cover



3 Choose endcap with bypass or blind endcap

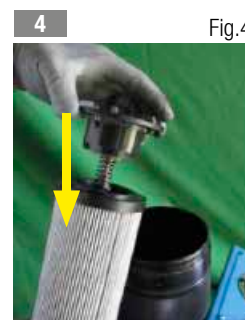

4 Insert the endcap with bypass (Fig. 4) or the possibly selected blind endcap (Fig. 5) in the filter element



5 Insert the filter element into the filter body



6 Screw on the cover



7 Make sure the air vent is closed

These operations must be performed with the machine off. Do not turn on the unit without first installing the filter element.



We recommend using only original MP Filtri filter cartridges.



## 6.3 Wiring diagram

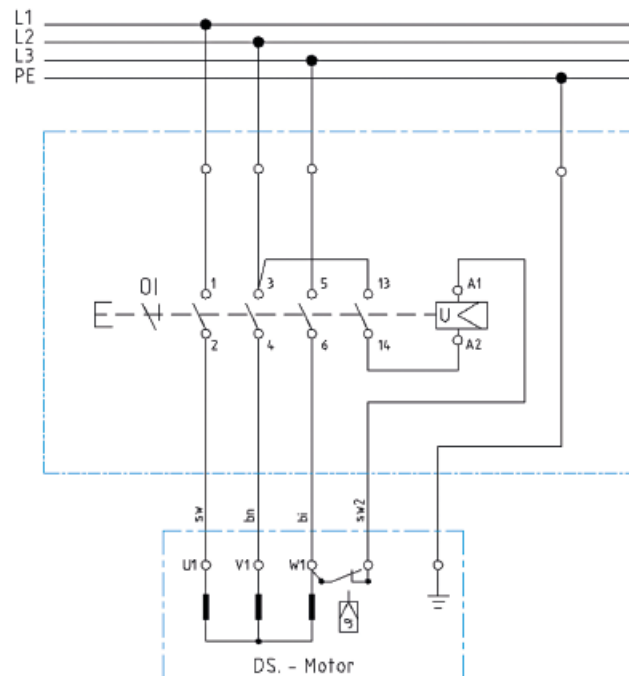

### 6.3.1 Electrical connection

The trolley must be connected via the plug supplied to the power supply, checking:

- the laws and technical specifications valid in the place and at the time of installation
- that the power supply voltage and the frequency at the connection point are compatible with those indicated on the rating plate of the mobile filtration unit
- the data shown on the rating plate.

It is recommended to use a multi-wire cable with a minimum cross-section of  $4 \times 2,5 \text{ mm}^2$  for the connection of the electric motor. The red plug indicates a three-phase motor, the blue plug a single-phase motor.

The supply voltage must correspond to the voltage specified on the rating plate.

The construction features of the electric cable guarantee great flexibility, excellent resistance to weather conditions, oils and greases, mechanical and thermal stresses: Standard IMQ-CPT-007, CEI EN 50525-2-2.

Compliant with requirements of the BT 2006/95/CE directives.

The terminal box contains metal elements that are under hazardous voltage; after making the connections, always close the box cover.



NOTE

### 6.3.2 Triangular electrical connection of a three-phase motor

This motor is connected to the three-phase line, which can be 230 V or more commonly 400 V. Since the windings that make up the motor must be powered at 230 V, the connection must be made in the following manner:

- *Delta connection: this connection applies the same voltage to the windings as to the line.*

To be able to change the direction of rotation it is sufficient to turn the selector (see photo on the right).



### 6.3.3 Electrical connection of a single-phase motor - not applicable for UFM919

# UFM919

## 6.3.4 Electrical panel

### Version with three-phase motor



UFM919TA3020P01

### Version with three-phase motor and particle counter



UFM919TA3021P01

### Labels on the electrical panel

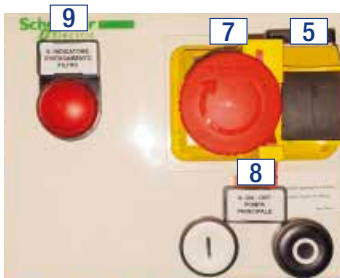

Version with electric differential indicator, red led alarm (9) on panel



Version with electric differential indicator, blue led alarm (9) on panel (for particle counter's version only)

## 6.3.5 Electrical panel labels

NOTE

Pos.	Translation of electrical panel labels				
	ENGLISH	ITALIAN	FRENCH	GERMAN	SPANISH
1	VOLTAGE ON	TENSIONE	APPAREIL SOUS TENSION	SPANNUNG EIN	TENSIÓN ACTIVA
2	PHASE REVERSE	FASE ROVESCIA	INVERSION DE PHASE	PHASENUMKEHR	INVERSIÓN FASE
3	ICM ALARM	ALLARME ICM	ALARME ICM	ALARM ICM	ALARMA ICM
4	THERMAL ALARM	TERMICO	ALARME THERMIQUE	WÄRMEALARM	ALARMA TÉRMICA
5	ON-OFF GENERAL	ACCESO/SPENTO	INTERRUPTEUR MARCHÉ/ ARRÊT GÉNÉRAL	EIN-/AUSSCHALTER	ON-OFF GENERAL
6	FLOW RATE SELECTOR 1 90 l/min 2 180 l/min	SELETTORE DI PORTATA 1 90 l/min 2 180 l/min	SELECTEUR DÉBIT 1 90 l/min 2 180 l/min	DURCHFLUSS SELEKTOR 1 90 l/min 2 180 l/min	SELECTOR DE CAUDAL 1 90 l/min 2 180 l/min
7	EMERGENCY STOP	STOP EMERGENZA	ARRÊT D'URGENCE	NOTABSCHALTUNG	PARADA EMERGENCIA
8	ON-OFF MAIN PUMP	ON-OFF POMPA PRINCIPALE	MARCHE/ARRÊT POMPE PRINCIPALE	EIN-AUS HAUPTPUMPE	ON-OFF BOMBA PRINCIPAL
9	FILTER ELEMENT CLOGGING	INDICATORE D'INTASAMENTO FILTRO	ÉLÉMENT FILTRANT OBSTRUÉ	FILTEREINSATZ VERSTOPFT	ATASCO ELEMENTO FILTRO
10	ON-OFF COUNTER AND AUXILIARY PUMP	ON-OFF CONTATORE E POMPA SECONDARIA	MARCHE/ARRÊT COMPTEUR ET POMPE AUXILIAIRE	EIN-AUS ZÄHLER UND HILFSPUMPE	ON-OFF CONTADOR Y BOMBA AUXILIAR

The mobile filtration unit is supplied with labels in English

NOTE

## 6.4 Use

### 6.4.1 Installation

The mobile filtration unit must be positioned in a place that guarantees its stability during use.

#### TRANSFER

Connect/immerse the metal suction lance (IN) to the tank or to the drum, immerse the discharge hose (OUT) in the machine tank or in the drum which should be transferred to.

If the transfer oil has to be cleaned, it is advisable to filter the oil contained in the drum or tank several times before being transferred.

In this case immerse the metal suction lances (IN) and the discharge lances (OUT) in the drum or oil tank to be transferred. Be careful that the lances remain below the level of the oil to be transferred in order to avoid foaming and cavitation; space the ends of the two lances as far as possible from each other in order to recirculate all the fluid and not generate an emulsion.

#### FILTRATION

Immerse the metal suction lances (IN) and the discharge lances (OUT) inside the tank far from each other, possibly positioning them at different heights (100 mm suction from the tank bottom, immersed delivery for a minimum of 200 mm).

Make sure that the tubes/lances are properly fixed or perfectly stable before starting.

Be careful not to mix up the suction and discharge hoses. The suction hose (IN) is the one with the largest diameter.

The discharge lance must in general have unrestricted flow. It is prohibited to install taps or components on both hoses that may obstruct or reduce the flow of the fluid.





# UFM919

## 6.4.2 Power on

Insert the electric plug into a three-phase socket (Fig. 6) depending on the version (check the voltage).

Check the direction of rotation in the version with three-phase motor: Operate the switch for a few seconds and observe the direction of rotation of the electric motor. The direction observed on the fan side must be clockwise, otherwise the phases L1 and L2 must be inverted (Fig. 7). **NOTE**

Three-phase electric power supply with protective conductor is required for the power supply of the trolley.



Electrical connection for the three-phase motor (5 poles plug)



Not phase inverter Fig.7



5 poles plug for the three-phase motor



Before starting up the electric motor, make sure that the suction lance (IN) is immersed in the fluid.



Operate the switch for a few seconds and observe the direction of rotation. The direction observed on the fan side must be clockwise, otherwise the phases L1 and L2 must be inverted.

**NOTE**

Models:  
UFM919TA3020P01

Once the plug has been inserted, press the button a (Fig. 8 - general power supply), press the ignition switch "I" on the electrical panel (Fig. 9). At this point the transfer and filtration of the fluid begins.

Button  
general power supply



With electric indicator

Button  
ON/OFF



With electric indicator

Models:  
UFM919TA3021P01

Once inserted, turn the switch to "I" (Fig. 10 - General power supply), then press the on button "I" on the electrical panel (Fig. 11). At this point the transfer and filtration of the fluid begins.

Button  
general power supply



With electric indicator and particle counter

Button  
ON/OFF



With electric indicator and particle counter

### 6.4.3 Air vent

When the unit is turned on for the first time after having inserted or replaced the filter element, drain the air inside the filter body using the vent valve (Fig. 12) on the cover. Once the air has been removed, close the vent valve.



Air vent Fig.12

Collect the oil in a container and dispose of it in accordance with the regulations in force.



NOTE

### 6.4.4 Oil analysis with particle counter

The ICMWMKUG12.0 series particle counter versions allow contamination counting and classification according to the international standards ISO 4406 - NAS 1638 - AS4059 Tab.1 - AS4059 Tab.2.

The particle counter also supplies the value of the water content in the oil and the temperature via an internal sensor.

It is possible to program the particle counter by connecting it via the ICMUSBI module (supplied) to a Personal Computer.

It is possible to enter a default value for the cleanliness class (according to the regulations used).

NOTE

When this value is reached, the unit switches off automatically.



Motor/pump assembly and pressure relief valves for the use of the particle counter



Start/Stop auxiliary pump for particle counter Fig.13



Manual activation of particle counter Fig.14

To commission the ICM, switch on the auxiliary pump and the particle counter using the selector in the electrical panel (Fig. 13), then wait 5 minutes after switching on before counting. To carry out the count, activate the particle counter button (Fig. 14).

Before starting the particle counter auxiliary pump, make sure that the main pump has been running for about 5-6 minutes and that the hoses are full of oil.



CAUTION

For more technical details please refer to the documentation available on the website [www.mpfiltri.com](http://www.mpfiltri.com) and downloadable via QR-Codes on page 13.

NOTE

# UFM919

## 6.4.5 Shutdown

Models:  
UFM919TA3020P01

Once the operations have been completed, switch off the electric pump, press the shutdown button to "0" on the electrical panel (Fig. 15) and disconnect the electrical connection plug.

Button  
ON/OFF

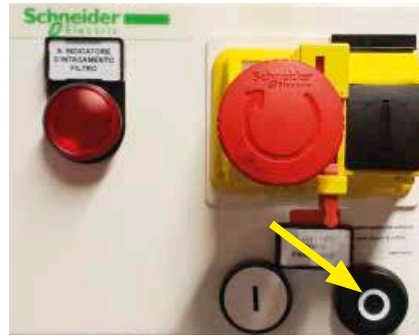

With electric indicator

Fig.15

Models:  
UFM919TA3021P01

Once the operations have been completed, switch off the electric pump, press the button "0" on the electrical panel (Fig. 16), turn the shutdown switch to "0" (Fig. 17 - General power supply) and disconnect the electrical connection plug.

If the particle counter is used, switch off the auxiliary unit before the main electric pump by turning the pump shut-off switch (Fig. 18).

Button  
ON/OFF



With electric indicator  
and particle counter

Fig.16

Button  
general power supply



With electric indicator  
and particle counter

Fig.17

Button  
ON/OFF



With electric indicator  
and particle counter

Fig.18

Put the lances in their respective housings (⚠ - Fig. 19), anchored to the frame paying attention to the fluid still present in the hoses. Rewind the power supply cable.



Lance holders

Fig.19

The UFM919 is equipped with a thermal protection device against electrical overloads, short circuits and overheating. If a "BLOCK" occurs, check the operating conditions (e.g. clogged filter, fluid conditions, motor overheating, etc.) and reset the thermal protection by pressing the appropriate button on the side of the motor terminal box.

With oil temperatures above 40/45 °C, give special caution to the handling of the metal lances/tubes and movement of the trolley. Avoid direct contact with hot oil, the mobile filtration unit and its installed components.



## 6.4.6 Operating limits and environmental limits

The trolley is designed to operate at a maximum pressure of 10 bar.

The electric motor is designed to operate according to the rating plate data.

For use in environments with very cold or very hot temperatures, refer to the technical data provided in Section 5.

## 6.5 Normal and scheduled maintenance

The UFM919 does not require particular maintenance interventions, it is in any case a good rule to check the perfect condition of the suction and discharge hoses before each use. Check that the filter element is correctly installed and that the filter cover is tightly screwed on.

Periodically check the tightness of the hydraulic connections and if the electrical cable ends in the motor terminal box are tight. Also check the cleanliness of the "Y" shaped filter for any accumulated macro impurities, so as to preserve the filter element (CU4006). Check the expiration date of the particle counter calibration certificate.

To keep the efficiency of the particle counter high, it is advisable to send it once a year to our headquarters for inspection, monitoring, testing on the test bench and issuing a new calibration certificate.



### 6.5.1 Oil leaks

Oil leaks can form on the joints of the hoses and on fittings if any connections or screws are loosened, in which case we recommend checking the correct tightness.

If the operations described above are not able to solve the problem, contact the manufacturer.

## 6.6 Filter clogging

- Versions with electric differential pressure indicator for blockage

UFM919TA3020P01 - UFM919TA3021P01

The conditions related to the blockage of the filter element are ensured by an electric indicator (Fig. 20) mounted on the head of the LMP430 filter. When the differential pressure of 3 bar is reached, the electric signal switches off the machine and turns on the light on the electrical panel. Replace the filter element.

All models are equipped with a pressure gauge (Fig. 21) with 10 bar full scale to measure the circuit pressure.

For signalling the clogged filter, refer to the differential pressure indicators.

The LMP430 filter is equipped with a bypass valve with a response pressure set at 3.5 bar.



Version with electric indicator

Fig.20



Pressure gauge

Fig.21

It is recommended to never exceed the response pressure of the bypass valve (3.5 bar).













## 6.6.1 Replacing the filter element

Before proceeding with the replacement of the filter element, make sure that the oil temperature is lower than +40/45 °C. Replace the filter element whenever necessary, i.e. whenever the differential pressure indicator indicates a clogged filter or when different fluids must be filtered.

The filtration of the filter element takes place from the outside to the inside, drain the residual oil into the body as it is not normally clean.

The oil must always be emptied using the drain valve (Fig. 22) located at the base of the filter body, clean the inside of the container. It is recommended to clean the filter cover carefully before beginning the operations for replacing the filter element.

<p><b>1</b></p> 	<p><b>2</b></p> 	<p><b>3</b></p> 	<p><b>4</b></p> 
<p>Open the vent valve</p>	<p>Drain the oil using the oil drain</p>	<p>Unscrew the filter cover</p>	<p>Remove the filter element</p>
<p><b>5</b></p> 	<p><b>6</b></p> 	<p><b>7</b></p> 	<p><b>Fig.24</b></p> 
<p>Remove the bypass or blind endcap</p>	<p>Make sure the container is securely tightened</p>	<p>Insert endcap w/ bypass (Fig. 23) or possibly used blind endcap (Fig. 24) in the new filter element</p>	
<p><b>8</b></p> 	<p><b>9</b></p> 	<p><b>10</b></p> 	
<p>Insert the new filter element</p>	<p>Screw on the cover</p>	<p>Close the air vent</p>	

Collect the replaced oil and filter element in a container and dispose of it in accordance with the regulations in force.

 **NOTE**

Any intervention must be carried out with the machine off. Always remember to unplug the power supply.

 **CAUTION**

## 6.6.2 Air vent

When the unit is first turned on after replacing the filter element, drain the air inside the filter body using the vent valve (Fig. 25) on the cover. Once the air has been removed, close the vent valve.



Air vent

Fig.25

Collect the oil in a container and dispose of it in accordance with the regulations in force.



NOTE

## 6.6.3 Replacing and cleaning of the filter in the suction line

Regularly (every 6 months or if you hear pump cavitation noises) check the blockage status of the suction filter and clean or replace it if necessary.



Suction filter



Unscrew the nut and remove the filter element

Collect the replaced oil and filter element in a container and dispose of it in accordance with the regulations in force.



NOTE

Any intervention must be carried out with the machine off. Always remember to unplug the power supply.



CAUTION

## 7 Designation & ordering code

MOBILE FILTRATION UNIT										
Series	Configuration example: UFM 919 T A 3 0 2 0 P01									
<b>UFM</b>										
Size										
<b>919</b>	90-180 l/min									
Electric motor										
<b>T</b>	400/230V Three phase - 2/4 pole									
Seals										
<b>A</b>	NBR									
Pressure gauges and Clogging indicators (see below)										
<b>3</b>	Manometer (*) + Electrical diff. clogging indicator (visual indication on panel)									
Filter element										
<b>0</b>	Without element (for ordering, see below)									
Filtration surface										
<b>2</b>	Higher									
Option										
<b>0</b>	No options									
<b>1</b>	ICM 2.0 particle counter									
Option										
<b>P01</b>	MP Filtri standard									
<b>Pxx</b>	Customized									

### Filtration element should be ordered separately

FILTRATION SURFACE - HIGHER		WATER REMOVAL
Inorganic microfibre	Wire mesh element	Multi-Layer water absorber
CJ 400 6 A01 A N P01	CJ 400 6 M25 A N P01	CJ4006WA025ANP01
CJ 400 6 A03 A N P01	CJ 400 6 M60 A N P01	
CJ 400 6 A06 A N P01		
CJ 400 6 A10 A N P01		
CJ 400 6 A16 A N P01		
CJ 400 6 A25 A N P01		

### CLOGGING INDICATORS (\*)

<b>DEA</b>	Electrical Differential Indicator (visual indication on panel)	
Settings	Ordering code	
3.0 bar ±10%	DE A 30 P01	

## 8 Spare parts

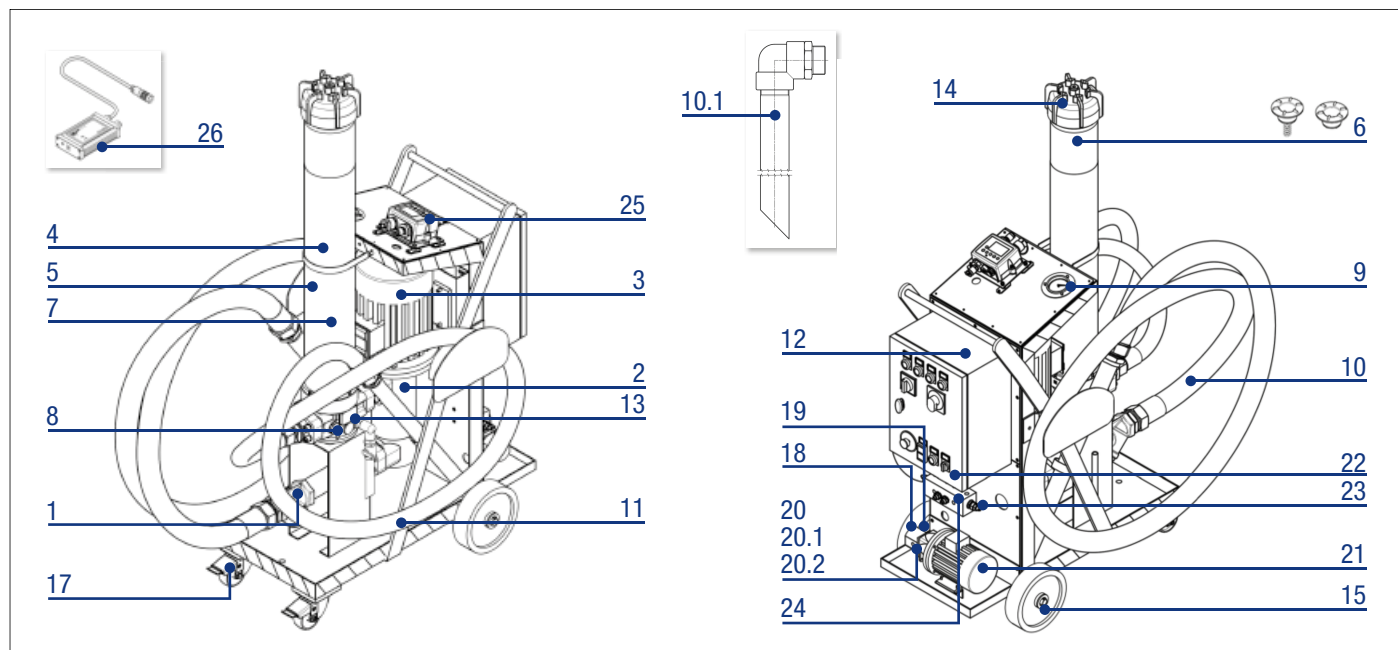

### 8.1 List of spare parts

Position	Series	Description	Code	Quantity
1	UFM919TA3020P01 UFM919TA3021P01	Y-shaped filter 2" BSP - 900 µm	02200041	1
2	UFM919TA3020P01 UFM919TA3021P01	GR45 SMT16B-180L/AC28 B5 RF3 Screw pump with integrated pressure relief valve	02200042	1
3	UFM919TA3020P01 UFM919TA3021P01	3-phase el. motor 3.7/5 kW 2/4P B3B5 IP55 400/230V 50/60Hz CLASS IE3	02200035	1
4	UFM919TA3020P01 UFM919TA3021P01	Increased filter length	LMP4306BAF1P02	1
5	UFM919TA3020P01 UFM919TA3021P01	Microfibre filter element 1 µm Microfibre filter element 3 µm Microfibre filter element 6 µm Microfibre filter element 10 µm Microfibre filter element 16 µm Microfibre filter element 25 µm Filter element in wire mesh 25 µm Filter element in wire mesh 60 µm Water absorber filter element	CU4006A01ANP01 CU4006A03ANP01 CU4006A06ANP01 CU4006A10ANP01 CU4006A16ANP01 CU4006A25ANP01 CU4006M25ANP01 CU4006M60ANP01 CU4006WA025ANP01	1
6	UFM919TA3020P01 UFM919TA3021P01	Endcap with 3.5 bar bypass Blind endcap without bypass	02001414 01044108	1
7	UFM919TA3020P01 UFM919TA3021P01	Gasket kit for LMP430 filter	02050393	1
8	UFM919TA3020P01 UFM919TA3021P01	Electric differential pressure indicator (visual indication on panel)	DEA30HA50P01	1
9	UFM919TA3020P01 UFM919TA3021P01	Pressure gauge	MGF63G10	1
10	UFM919TA3020P01 UFM919TA3021P01	Flexible suction hose DN50 L = 3000 mm Inclined cut nozzle Øe = 50 L = 700 mm	02200044	1
10.1	UFM919TA3020P01 UFM919TA3021P01	Nozzle 90° for suction of oil from the drums Inclined cut nozzle Øe = 38 L = 700 mm	02200036	1

>> NEXT



# UFM919

Position	Series	Description	Code	Quantity
11	UFM919TA3020P01	Flexible delivery hose DN38 L = 3000 mm	02200043	1
	UFM919TA3021P01	Inclined cut nozzle $\varnothing_e = 42$ L = 700 mm		
12	UFM919TA3020P01	Electrical panel three-phase version + cable and CEE plug	02200037	1
	UFM919TA3021P01		02200038	
13	UFM919TA3020P01 UFM919TA3021P01	Drain valve	02200039	1
14	UFM919TA3020P01 UFM919TA3021P01	Air vent valve	02200040	1
15	UFM919TA3020P01 UFM919TA3021P01	Fixed wheel $\varnothing 200 \times 50 \times 20$ mm. Blue polyurethane coating and black polyamide structure	02200045	2
16	UFM919TA3020P01 UFM919TA3021P01	Swivel wheel with $\varnothing 80 \times 30 \times 20$ mm lock. Blue polyurethane coating and black polyamide structure	02200046	1
17	UFM919TA3020P01 UFM919TA3021P01	Swivel wheel $\varnothing 80 \times 30 \times 20$ mm. Blue polyurethane coating and black polyamide structure	02200047	1
18	UFM919TA3021P01	025-D-18 gear pump	02200048	1
19	UFM919TA3021P01	Pump bracket	LMG140MFS05M4SANU	1
20	UFM919TA3021P01	Pump side half-coupling	SGEA01FS05M	1
20.1	UFM919TA3021P01	Motor side half-coupling	SGEA01M01021FG	1
20.2	UFM919TA3021P01	Elastic wheel	EGE0	1
21	UFM919TA3021P01	Single-phase electric motor 0.18 kW 4P B3/B5 CLASS IE3	02200049	1
22	UFM919TA3021P01	Valve lock	02200050	1
23	UFM919TA3021P01	Relief valve	02200051	2
24	UFM919TA3021P01	1/4" pressure mini-plug	02200052	2
25	UFM919TA3021P01	Particle counter	ICMWMKUG12.0	1
26	UFM919TA3021P01	Communication module	ICMUSBI	1
27	UFM919TA3020P01 UFM919TA3021P01	Adapter for 5 to 4 poles plug for the three-phase motor	XXXXXX	1

## 8.2 Filter element detail

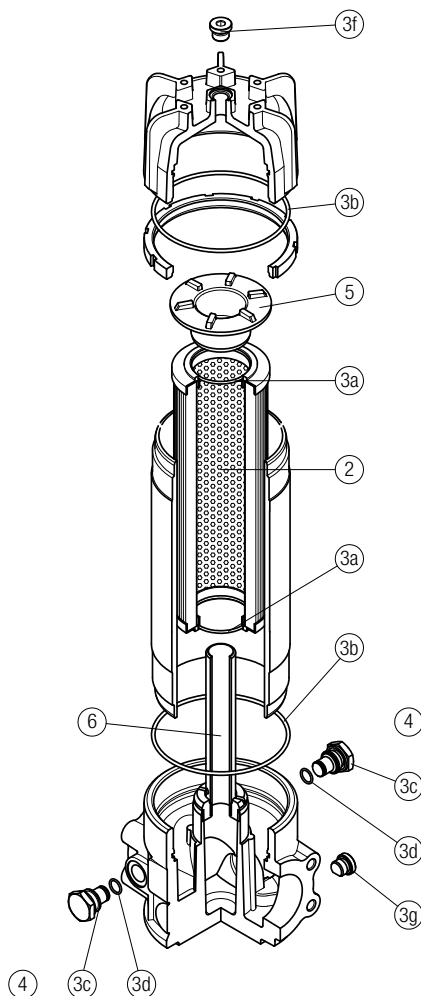

Item:	Q.ty: 1 pc.	Q.ty: 1 pc.	Q.ty: 2 pcs.	Q.ty: 2 pcs.	Q.ty: 1 pc.
Filter series	Filter element	Seal Kit code number NBR   FPM	Indicator connection plug NBR   FPM	Housing spigot no bypass   with bypass	Internal tube for low flow rate, execution P02
<b>LMP 430 length 6</b>	See spare parts (position 5)	02050393   02050394 (included with filter element)	T2H   T2V	01044108   02001414	02025042

All data, details and words contained in this publication are provided for use by technically qualified personnel at their discretion, without warranty of any kind.

MP Filtri reserves the right to make modifications to the models and versions of the described products at any time for both technical and/or commercial reasons.

For updated information please visit our website: [www.mpfiltri.com](http://www.mpfiltri.com)

The colors and the pictures of the products are purely indicative.

Any reproduction, partial or total, of this document is strictly forbidden.

All rights are strictly reserved





## WORLDWIDE NETWORK



CANADA  
CHINA  
FRANCE  
GERMANY  
INDIA

RUSSIAN FEDERATION  
SINGAPORE  
UNITED ARAB EMIRATES  
UNITED KINGDOM  
USA

**PASSION TO PERFORM**



[mpfiltri.com](http://mpfiltri.com)